

Flangering PP/stål PP 75 mm
SDR11 16bar DN65 sort
PN10/16 (0101934)



TEKNISKE SPECIFIKATIONER

Farve sort

Materiale PP/stål

Overfladebehandling PP

Klasse SDR11

Tryk 16 bar

Størrelse 75 mm

DN 65

Flange PN10/16

Ydre Ø 186 mm

Vægt 1.114 kg

Tykkelse 18 mm

Bolthul 18 mm

Huller 4

DIMENSIONER

O 18 mm

PCD 145 mm

ØDi-1

92 mm

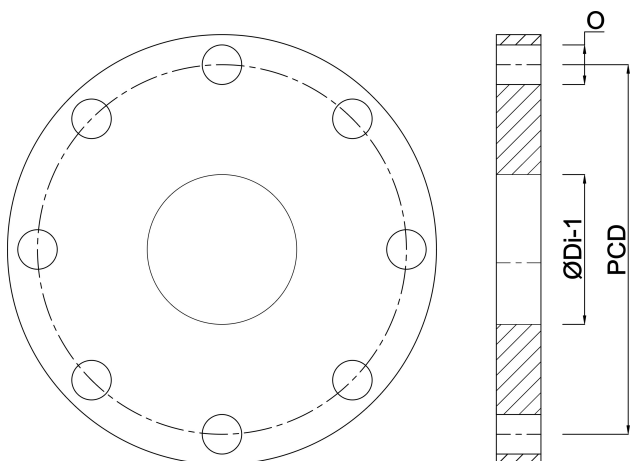

Genereret den: 22-05-2026

Bevo Nordic A/S
Pakhusgården 54
5000 Odense C
Danmark
+45 66 19 25 45
info@bevo.dk
<http://www.bevo.com>