

**Planflange rustfri stål 316
DN50 x 60,3 mm DIN flange x
stuksvejs 10bar DN50 PN10/16
(0080635)**



TEKNISKE SPECIFIKATIONER

Materiale	rustfri stål 316
Tilslutning	DIN flange x stuksvejs
DIN Standard	DIN 2576
Tryk	10 bar
Størrelse	DN50 x 60,3 mm
DN	50
Indre Ø	61,5 mm
Flange	PN10/16
Diameter	60,3 mm
Ydre Ø	165 mm
Vægt	2.5 kg
Tykkelse	20 mm
Bolthul	18 mm
Huller	4

DIMENSIONER

O	18 mm
---	-------

PCD 125 mm

ØDi-1 61.5 mm

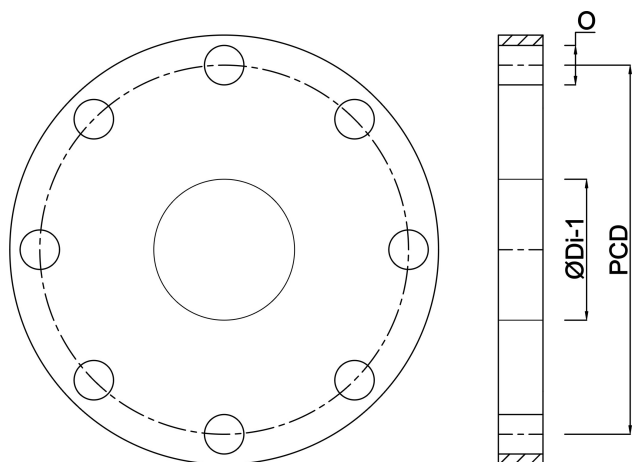

Genereret den: 22-05-2026

Bevo Nordic A/S
Pakhusgården 54
5000 Odense C
Danmark
+45 66 19 25 45
info@bevo.dk
<http://www.bevo.com>