

**Profec Gevind flange stål
zinkbelagt DN32 x 1 1/4" DIN
flange x indvendig gevind
DN32 PN10/16 (1080213)**



TEKNISKE SPECIFIKATIONER

Materiale	stål
Overfladebehandling	zinkbelagt
Tilslutning	DIN flange x indvendig gevind
DIN Standard	DIN 2566
Flange	PN10/16
Størrelse	DN32 x 1 1/4"
Bolt	
DN	32
Diameter	42,4 mm
Ydre Ø	140 mm
Vægt	1.6 kg
Tykkelse	16 mm
Bolthul	18 mm
Huller	4

DIMENSIONER

O	18 mm
---	-------

PCD 100 mm

ØDi-1 1 1/4 "

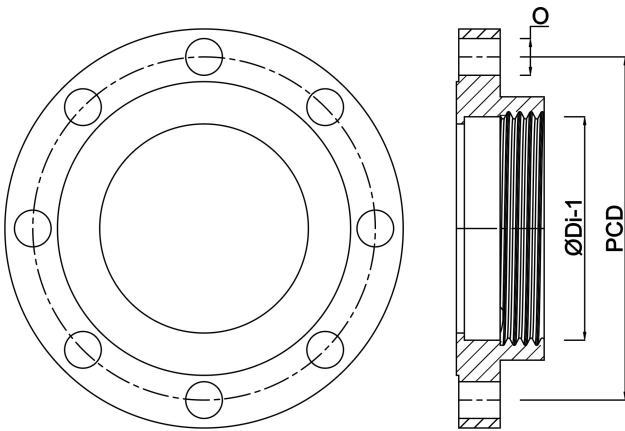

Genereret den: 24-05-2026

Bevo Nordic A/S
Pakhusgården 54
5000 Odense C
Danmark
+45 66 19 25 45
info@bevo.dk
<http://www.bevo.com>