

**Flangering PP/stål PP 200 mm  
SDR11 16bar DN200 sort PN10  
(0101941)**



# TEKNISKE SPECIFIKATIONER

Farve sort

Materiale PP/stål

Overfladebehandling PP

Klasse SDR11

Tryk 16 bar

Størrelse 200 mm

DN 200

Flange PN10

Ydre Ø 340 mm

Vægt 2.64 kg

Tykkelse 25 mm

Bolthul 22 mm

Huller 8

# DIMENSIONER

O 22 mm

PCD 295 mm

ØDi-1

235 mm

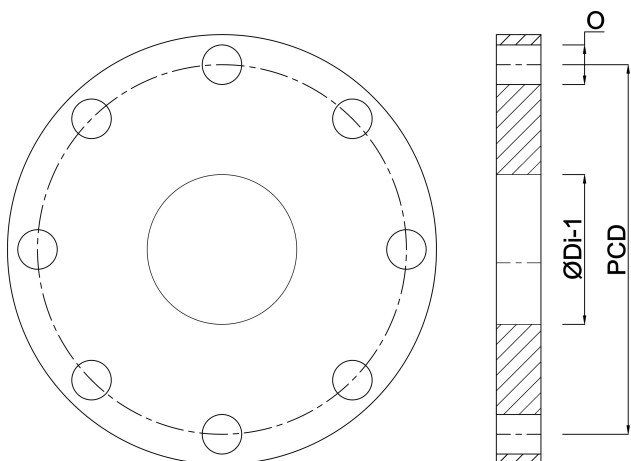

**Genereret den: 22-05-2026**

Bevo Nordic A/S  
Pakhusgården 54  
5000 Odense C  
Danmark  
+45 66 19 25 45  
[info@bevo.dk](mailto:info@bevo.dk)  
<http://www.bevo.com>