

Profec Flangering PP 200 mm 10bar DN175 sort PN10 (0101395)



TEKNISKE SPECIFIKATIONER

Farve sort

Materiale PP

Størrelse 200 mm

Pakning 9 stk.

DN 175

Indre Ø 227 mm

Flange PN10

Ydre Ø 315 mm

Tykkelse 32 mm

Tryk 10 bar

Bolthul 22 mm

Huller 8

DIMENSIONER

O 22 mm

PCD 270 mm

ØDi-1 227 mm

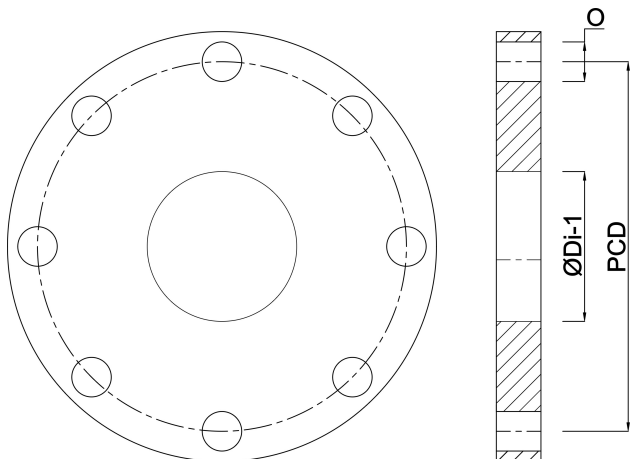

Genereret den: 22-05-2026

Bevo Nordic A/S
Pakhusgården 54
5000 Odense C
Danmark
+45 66 19 25 45
info@bevo.dk
<http://www.bevo.com>