

**Reduktionsmuffe PVC-U 315
mm x 250 mm limmuffe 10bar
grå type ekstruderet (0110691)**



TEKNISKE SPECIFIKATIONER

Farve	grå
Type	ekstruderet
Materiale	PVC-U
Tilslutning	limmuffe
Tryk	10 bar
Størrelse	315 mm x 250 mm

DIMENSIONER

L	510 mm
ØDi-1	315 mm
ØDi-2	250 mm

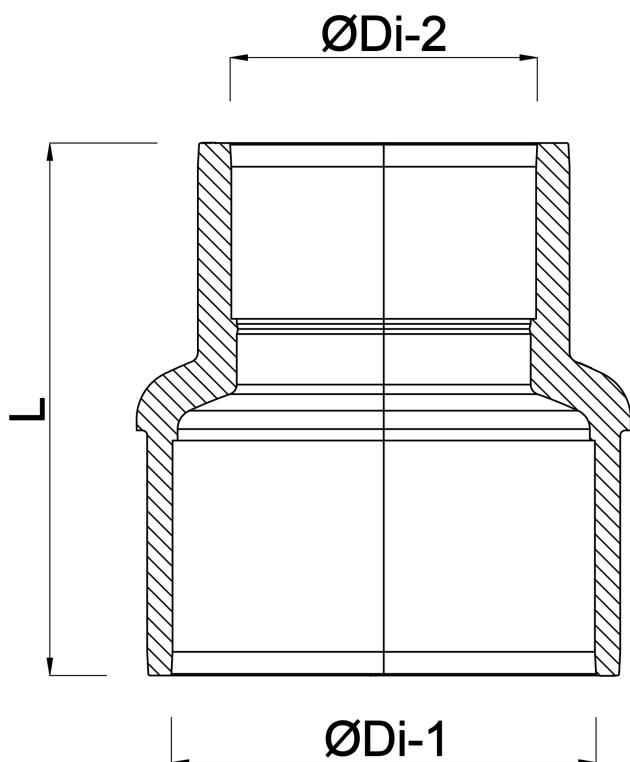

Genereret den: 25-05-2026

Bevo Nordic A/S
Pakhusgården 54
5000 Odense C
Danmark
+45 66 19 25 45
info@bevo.dk
<http://www.bevo.com>