

Flangering PP 140 mm 16bar DN125 sort PN10/16 (0101910)



TEKNISKE SPECIFIKATIONER

Farve sort

Materiale PP

Tryk 16 bar

Huller 8

Egnet til 0110908

Størrelse 140 mm

DN 125

Flange PN10/16

Ydre Ø 250 mm

Vægt 1.75 kg

Tykkelse 24 mm

Bolthul 18 mm

DIMENSIONER

O 18 mm

PCD 210 mm

ØDi-1 167 mm

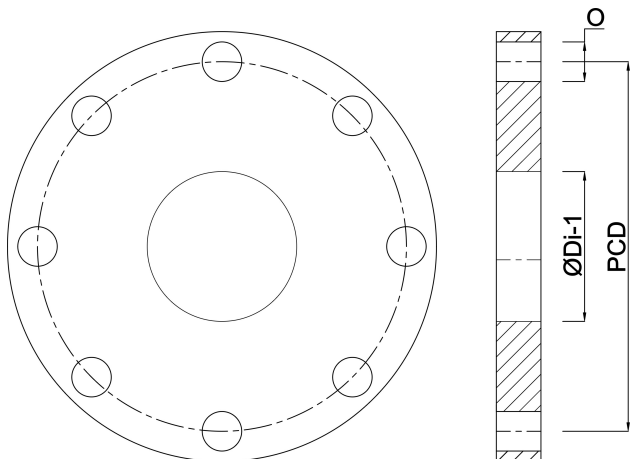

Genereret den: 22-05-2026

Bevo Nordic A/S
Pakhusgården 54
5000 Odense C
Danmark
+45 66 19 25 45
info@bevo.dk
<http://www.bevo.com>