

**Profec Flangeovergang PVC-U
DN32 x 40 mm DIN flange x
limmuffe 10bar DN32 grå PN10
(0111083)**



TEKNISKE SPECIFIKATIONER

Farve	grå
Materiale	PVC-U
Tilslutning	DIN flange x limmuffe
Størrelse	DN32 x 40 mm
Bolt	
DN	32
Flange	PN10
Ydre Ø	140 mm
Vægt	0.237 kg
Boltlængde	70 mm
Tykkelse	15 mm
Tryk	10 bar
Bolthul	18 mm
Huller	4

DIMENSIONER

O	18 mm
---	-------

PCD 100 mm

ØDi-1 40 mm

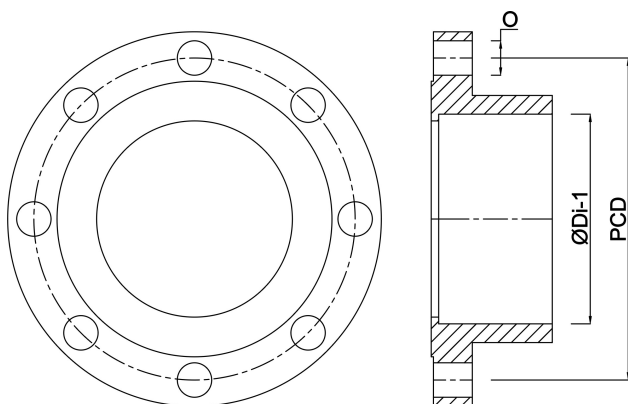

Genereret den: 23-05-2026

Bevo Nordic A/S
Pakhusgården 54
5000 Odense C
Danmark
+45 66 19 25 45
info@bevo.dk
<http://www.bevo.com>