

Planflange rustfri stål 316
DN40 x 48,3 mm DIN flange x
stuksvejs 10bar DN40 PN10/40
(0080634)



TEKNISKE SPECIFIKATIONER

Materiale	rustfri stål 316
Tilslutning	DIN flange x stuksvejs
DIN Standard	DIN 2576
Tryk	10 bar
Størrelse	DN40 x 48,3 mm
DN	40
Indre Ø	49,5 mm
Flange	PN10/40
Diameter	48,3 mm
Ydre Ø	150 mm
Vægt	2.1 kg
Tykkelse	18 mm
Bolthul	18 mm
Huller	4

DIMENSIONER

O	18 mm
---	-------

PCD 110 mm

ØDi-1 49.5 mm

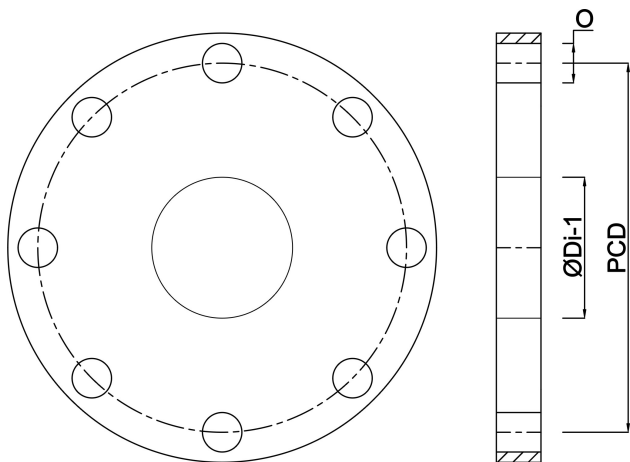

Genereret den: 22-05-2026

Bevo Nordic A/S
Pakhusgården 54
5000 Odense C
Danmark
+45 66 19 25 45
info@bevo.dk
<http://www.bevo.com>