

**Gevind flange rustfri stål 316
DN50 x DN50 x 2" DIN flange x
indvendig gevind 16bar DN50
PN16 (0080668)**



TEKNISKE SPECIFIKATIONER

Materiale	rustfri stål 316
Tilslutning	DIN flange x indvendig gevind
DIN Standard	DIN 2566
Størrelse	DN50 x DN50 x 2"
DN	50
Flange	PN16
Diameter	60,3 mm
Ydre Ø	165 mm
Vægt	2.4 kg
Tykkelse	18 mm
Tryk	16 bar
Bolthul	18 mm
Huller	4

DIMENSIONER

O	18 mm
PCD	125 mm

ØDi-1

2"

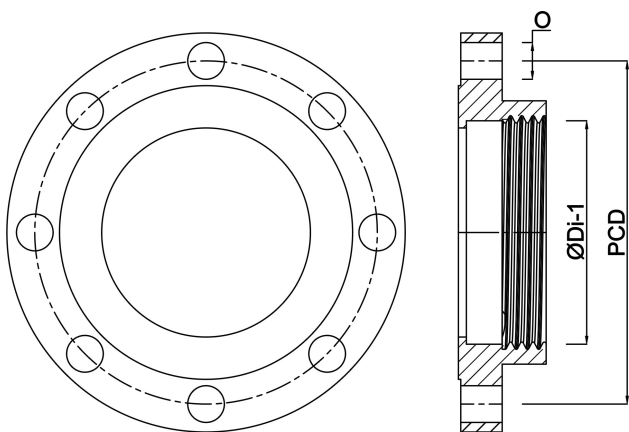

Genereret den: 22-05-2026

Bevo Nordic A/S
Pakhusgården 54
5000 Odense C
Danmark
+45 66 19 25 45
info@bevo.dk
<http://www.bevo.com>