

Prop PP 3/8" udvendig gevind 10bar grå (0330166)



TEKNISKE SPECIFIKATIONER

Farve	grå
Materiale	PP
Tilslutning	udvendig gevind
Tryk	10 bar
Maks. temp.	80 °C
Størrelse	3/8"

DIMENSIONER

H	21 mm
ØDo-1	3/8 "

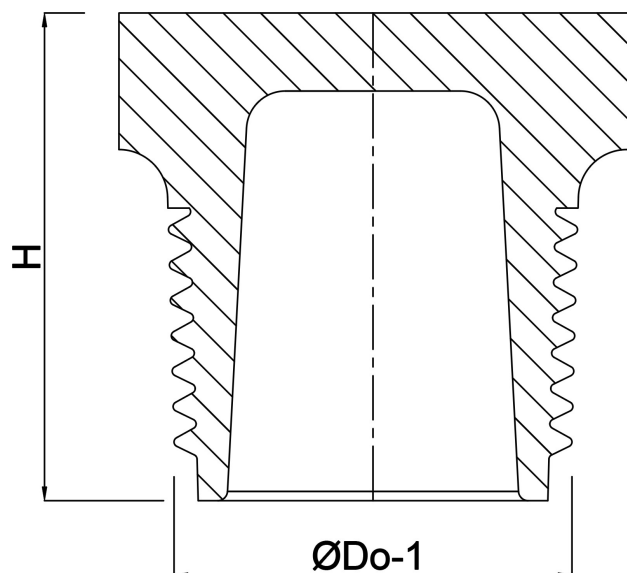

Genereret den: 23-05-2026

Bevo Nordic A/S
Pakhusgården 54
5000 Odense C
Danmark
+45 66 19 25 45
info@bevo.dk
<http://www.bevo.com>