

**Flangering PP/stål PP 225 mm
SDR11 16bar DN200 sort PN10
(0101942)**



TEKNISKE SPECIFIKATIONER

Farve sort

Materiale PP/stål

Overfladebehandling PP

Klasse SDR11

Tryk 16 bar

Størrelse 225 mm

DN 200

Flange PN10

Ydre Ø 340 mm

Vægt 2.68 kg

Tykkelse 25 mm

Bolthul 22 mm

Huller 8

DIMENSIONER

O 22 mm

PCD 295 mm

ØDi-1

238 mm

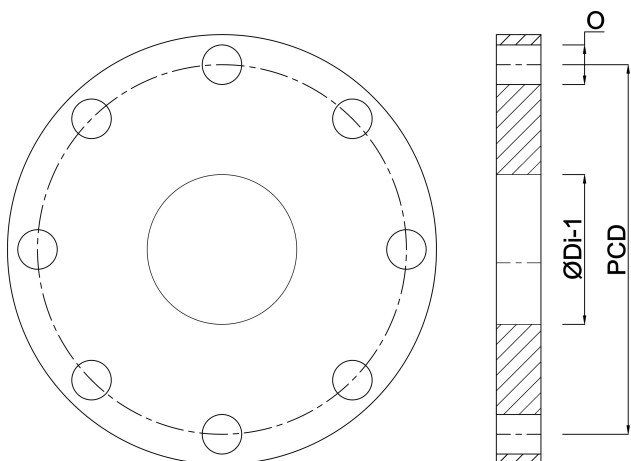

Genereret den: 22-05-2026

Bevo Nordic A/S
Pakhusgården 54
5000 Odense C
Danmark
+45 66 19 25 45
info@bevo.dk
<http://www.bevo.com>