

**Gevind flange rustfri stål 316
DN80 x DN80 x 3" DIN flange x
indvendig gevind 16bar DN80
PN16 (0080670)**



TEKNISKE SPECIFIKATIONER

Materiale	rustfri stål 316
Tilslutning	DIN flange x indvendig gevind
DIN Standard	DIN 2566
Størrelse	DN80 x DN80 x 3"
DN	80
Flange	PN16
Diameter	88,9 mm
Ydre Ø	200 mm
Vægt	3.8 kg
Tykkelse	20 mm
Tryk	16 bar
Bolthul	18 mm
Huller	8

DIMENSIONER

O	18 mm
PCD	160 mm

ØDi-1

3 "

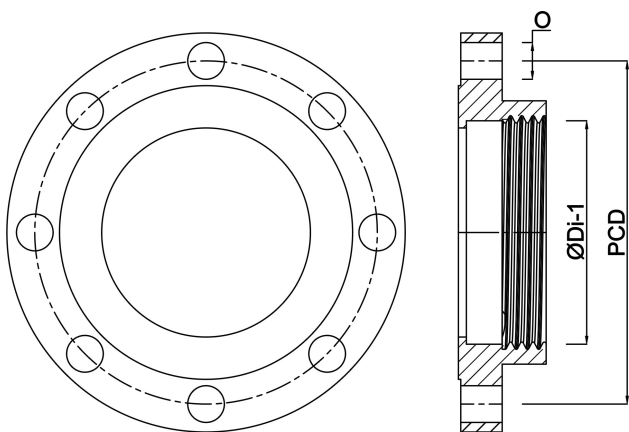

Genereret den: 22-05-2026

Bevo Nordic A/S
Pakhusgården 54
5000 Odense C
Danmark
+45 66 19 25 45
info@bevo.dk
<http://www.bevo.com>