

Flangering PP/stål PP 110 mm
SDR11 16bar DN100 sort
PN10/16 (0101936)



TEKNISKE SPECIFIKATIONER

Farve sort

Materiale PP/stål

Overfladebehandling PP

Klasse SDR11

Tryk 16 bar

Størrelse 110 mm

DN 100

Flange PN10/16

Ydre Ø 220 mm

Vægt 1.331 kg

Tykkelse 20 mm

Bolthul 18 mm

Huller 8

DIMENSIONER

O 18 mm

PCD 180 mm

ØDi-1

128 mm

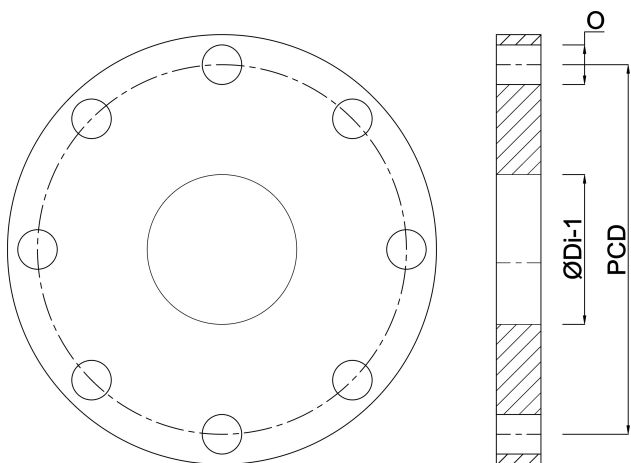

Genereret den: 22-05-2026

Bevo Nordic A/S
Pakhusgården 54
5000 Odense C
Danmark
+45 66 19 25 45
info@bevo.dk
<http://www.bevo.com>