

# Profec Svejseflange stål DN65 x 76,1 mm DIN flange x stuksvejs sort PN16 (1180482)



# TEKNISKE SPECIFIKATIONER

Farve sort

Materiale stål

Tilslutning DIN flange x stuksvejs

DIN Standard DIN 2633

Flange PN16

Størrelse DN65 x 76,1 mm

Ydre Ø 185 mm

Vægt 3.03 kg

Højde 45 mm

Tykkelse 18 mm

PCD 145 mm

Bolthul 18 mm

Huller 4

## DIMENSIONER

O 18 mm

PCD 145 mm

ØDi-1

70.3 mm

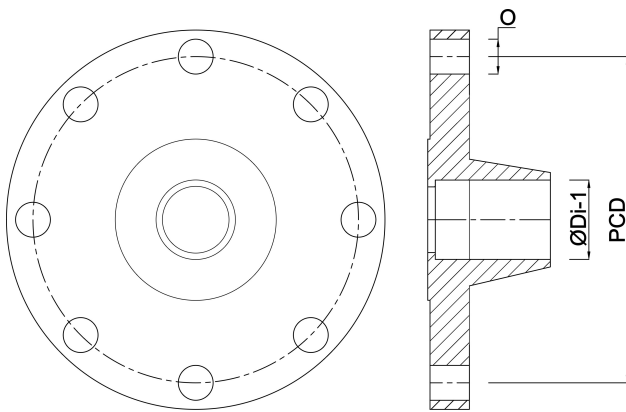

**Genereret den: 24-05-2026**

Bevo Nordic A/S  
Pakhusgården 54  
5000 Odense C  
Danmark  
+45 66 19 25 45  
[info@bevo.dk](mailto:info@bevo.dk)  
<http://www.bevo.com>