

**Profec Gevind flange stål
zinkbelagt DN50 x 2" DIN
flange x indvendig gevind
DN50 PN10/16 (1080215)**



TEKNISKE SPECIFIKATIONER

Materiale	stål
Overfladebehandling	zinkbelagt
Tilslutning	DIN flange x indvendig gevind
DIN Standard	DIN 2566
Flange	PN10/16
Størrelse	DN50 x 2"
Bolt	
DN	50
Diameter	60,3 mm
Ydre Ø	165 mm
Vægt	2.43 kg
Tykkelse	18 mm
Bolthul	18 mm
Huller	4

DIMENSIONER

O	18 mm
---	-------

PCD

125 mm

ØDi-1

2"

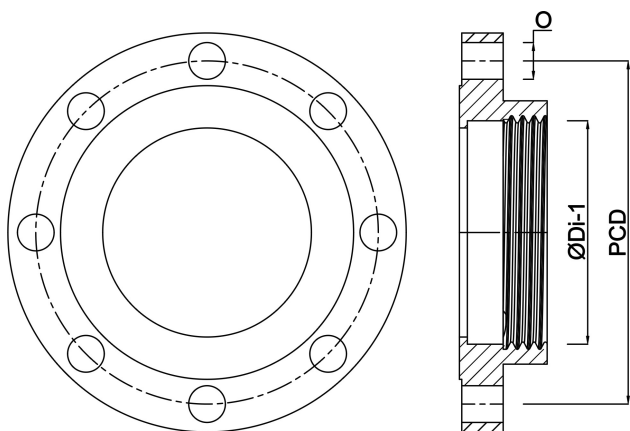

Genereret den: 24-05-2026

Bevo Nordic A/S
Pakhusgården 54
5000 Odense C
Danmark
+45 66 19 25 45
info@bevo.dk
<http://www.bevo.com>