

**Profec Flange PVC-U DN100 x
4" DIN flange x indvendig
gevind 16bar DN100 grå
PN10/16 (0111168)**

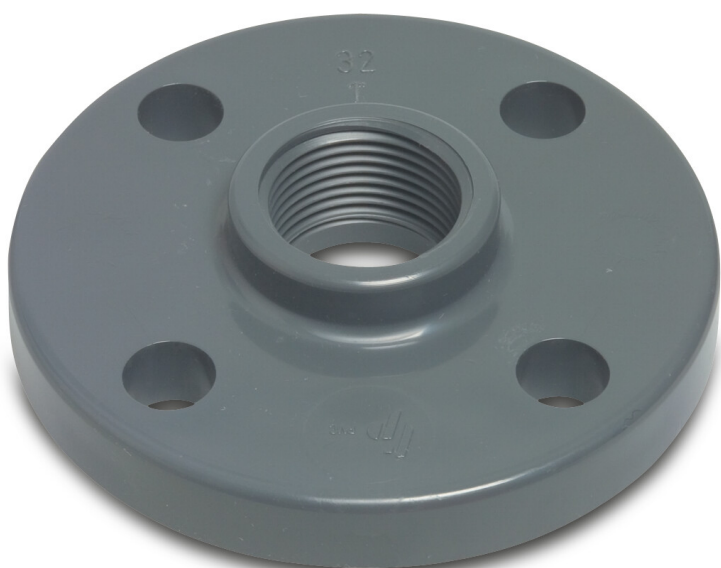

TEKNISKE SPECIFIKATIONER

Farve	grå
Materiale	PVC-U
Tilslutning	DIN flange x indvendig gevind
Flange	PN10/16
Tryk	16 bar
Størrelse	DN100 x 4"
DN	100
Ydre Ø	220 mm
Vægt	0.89 kg
Tykkelse	22 mm
Bolthul	18 mm
Huller	8

DIMENSIONER

O	18 mm
PCD	180 mm
ØDi-1	4"

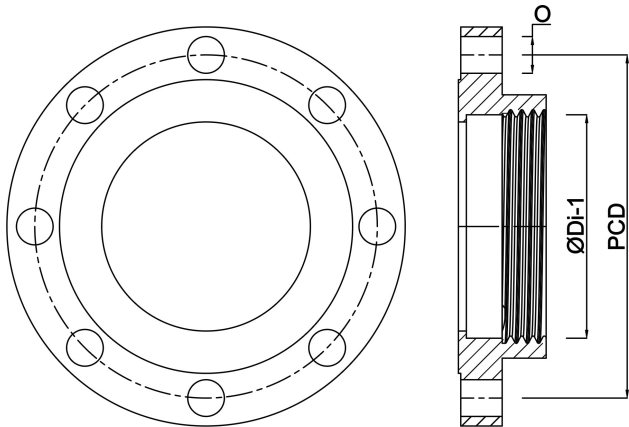

Genereret den: 23-05-2026

Bevo Nordic A/S
Pakhusgården 54
5000 Odense C
Danmark
+45 66 19 25 45
info@bevo.dk
<http://www.bevo.com>