

**Profec Flangeovergang PVC-U
DN40 x 50 mm DIN flange x
limmuffe 10bar DN40 grå PN10
(0111084)**



TEKNISKE SPECIFIKATIONER

Farve	grå
Materiale	PVC-U
Tilslutning	DIN flange x limmuffe
Størrelse	DN40 x 50 mm
Bolt	
DN	40
Flange	PN10
Ydre Ø	150 mm
Vægt	0.28 kg
Boltlængde	75 mm
Tykkelse	16 mm
Tryk	10 bar
Bolthul	18 mm
Huller	4

DIMENSIONER

O	18 mm
---	-------

PCD

110 mm

ØDi-1

50 mm

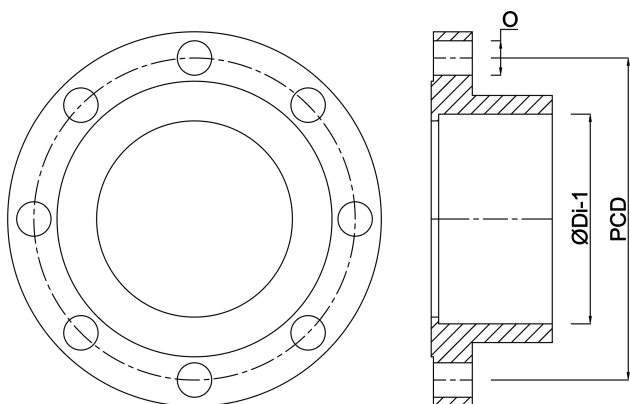

Genereret den: 23-05-2026

Bevo Nordic A/S
Pakhusgården 54
5000 Odense C
Danmark
+45 66 19 25 45
info@bevo.dk
<http://www.bevo.com>