

**Profec Gevind flange stål
zinkbelagt DN100 x 4" DIN
flange x indvendig gevind
DN100 PN10/16 (1080218)**



TEKNISKE SPECIFIKATIONER

Materiale	stål
Overfladebehandling	zinkbelagt
Tilslutning	DIN flange x indvendig gevind
DIN Standard	DIN 2566
Flange	PN10/16
Størrelse	DN100 x 4"
Bolt	
DN	100
Diameter	114,3 mm
Ydre Ø	220 mm
Vægt	4.47 kg
Tykkelse	20 mm
Bolthul	18 mm
Huller	8

DIMENSIONER

O	18 mm
---	-------

PCD

180 mm

ØDi-1

4 "

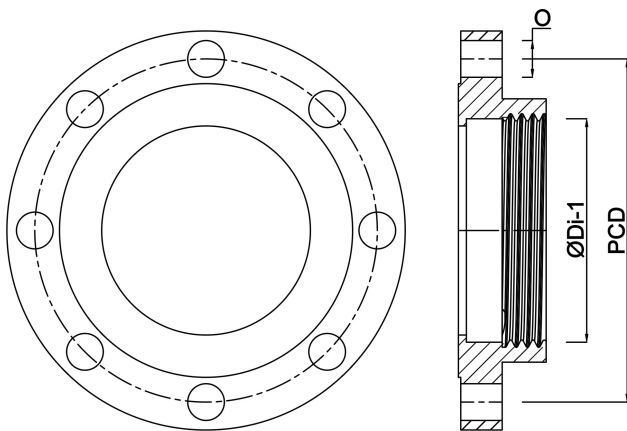

Genereret den: 24-05-2026

Bevo Nordic A/S
Pakhusgården 54
5000 Odense C
Danmark
+45 66 19 25 45
info@bevo.dk
<http://www.bevo.com>