

**Profec Flangeovergang PVC-U
DN150 x 160 mm DIN flange x
limmuffe 10bar DN150 grå
PN10/16 (0111052)**

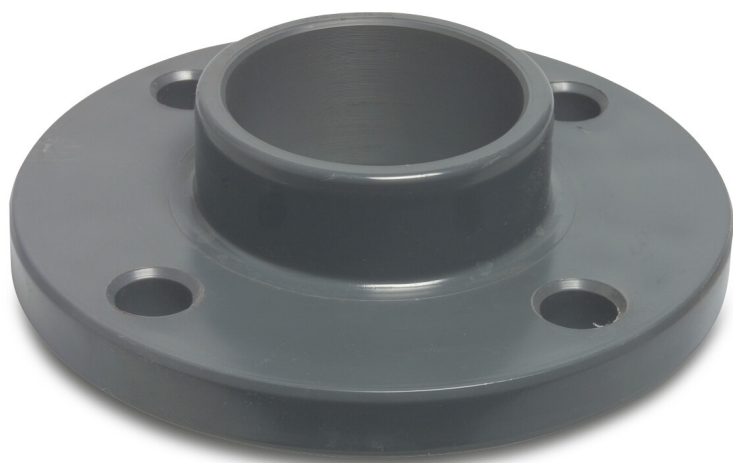

TEKNISKE SPECIFIKATIONER

Farve	grå
Materiale	PVC-U
Tilslutning	DIN flange x limmuffe
Størrelse	DN150 x 160 mm
Bolt	
DN	150
Flange	PN10/16
Ydre Ø	285 mm
Vægt	2.008 kg
Boltlængde	90 mm
Tykkelse	30 mm
Tryk	10 bar
Bolthul	22 mm
Huller	8

DIMENSIONER

O	22 mm
---	-------

PCD 240 mm

ØDi-1 160 mm

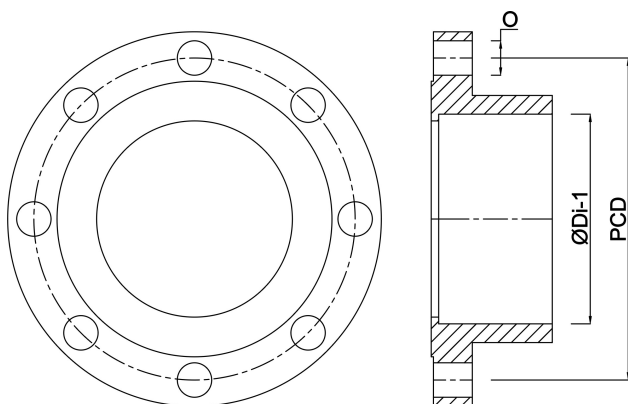

Genereret den: 23-05-2026

Bevo Nordic A/S
Pakhusgården 54
5000 Odense C
Danmark
+45 66 19 25 45
info@bevo.dk
<http://www.bevo.com>