

**Profec Flangeovergang PVC-U
DN65 x 75 mm DIN flange x
limmuffe 16bar DN65 grå
PN10/16 (0111046)**



TEKNISKE SPECIFIKATIONER

Farve	grå
Materiale	PVC-U
Tilslutning	DIN flange x limmuffe
Størrelse	DN65 x 75 mm
Bolt	
DN	65
Flange	PN10/16
Ydre Ø	185 mm
Vægt	0.555 kg
Boltlængde	90 mm
Tykkelse	19 mm
Tryk	16 bar
Bolthul	18 mm
Huller	4

DIMENSIONER

O	18 mm
---	-------

PCD

145 mm

ØDi-1

75 mm

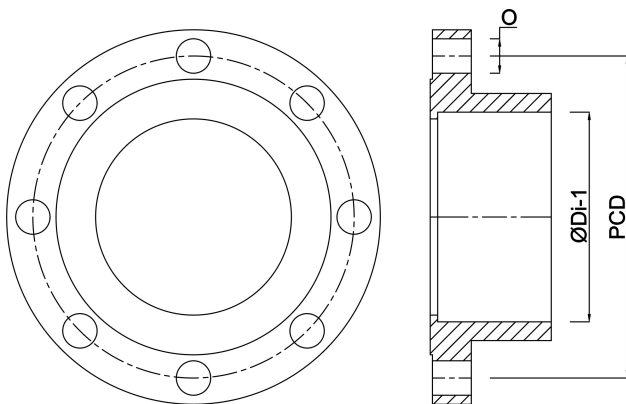

Genereret den: 19-06-2026

Bevo Nordic A/S
Pakhusgården 54
5000 Odense C
Danmark
+45 66 19 25 45
info@bevo.dk
<http://www.bevo.com>