

**Flange PP DN80 x 3" DIN flange  
x indvendig gevind 6bar DN80  
sort PN10/16 type forstærket  
(0707207)**



# TEKNISKE SPECIFIKATIONER

Farve	sort
Type	forstærket
Materiale	PP
Pakningsmateriale	gummi
Tilslutning	DIN flange x indvendig gevind
Flange	PN10/16
Tykkelse	18 mm
Bolthul	18 mm
Størrelse	DN80 x 3"
Pakning	65 stk.
DN	80
Ydre Ø	195 mm
Tryk	6 bar
Huller	8

## DIMENSIONER

O	18 mm
---	-------

PCD

160 mm

ØDi-1

3 "

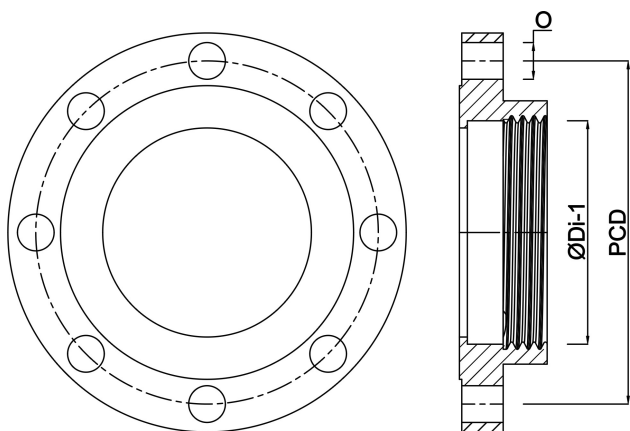

**Genereret den: 24-05-2026**

Bevo Nordic A/S  
Pakhusgården 54  
5000 Odense C  
Danmark  
+45 66 19 25 45  
[info@bevo.dk](mailto:info@bevo.dk)  
<http://www.bevo.com>