

**Profec Flange PVC-U DN32 x 1
1/4" DIN flange x indvendig
gevind 16bar DN32 grå
PN10/16 (0111163)**

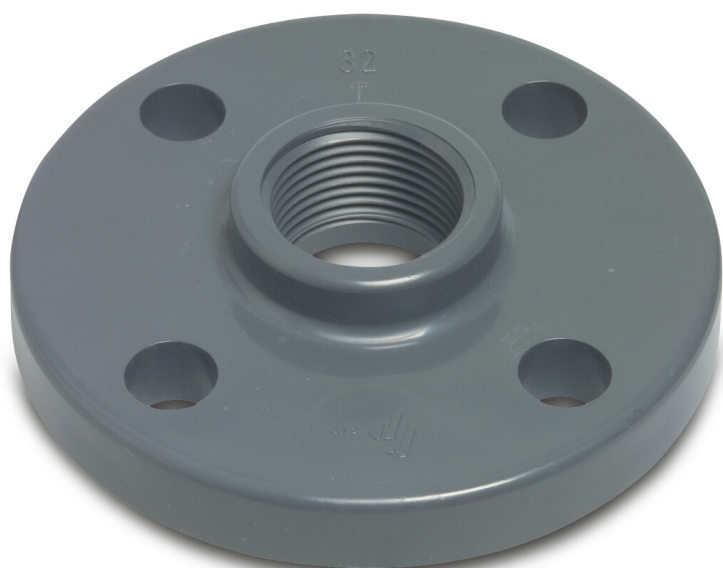

TEKNISKE SPECIFIKATIONER

Farve	grå
Materiale	PVC-U
Tilslutning	DIN flange x indvendig gevind
Flange	PN10/16
Tryk	16 bar
Størrelse	DN32 x 1 1/4"
DN	32
Ydre Ø	140 mm
Vægt	0.223 kg
Tykkelse	15 mm
Bolthul	18 mm
Huller	4

DIMENSIONER

O	18 mm
PCD	100 mm
ØDi-1	1 1/4"

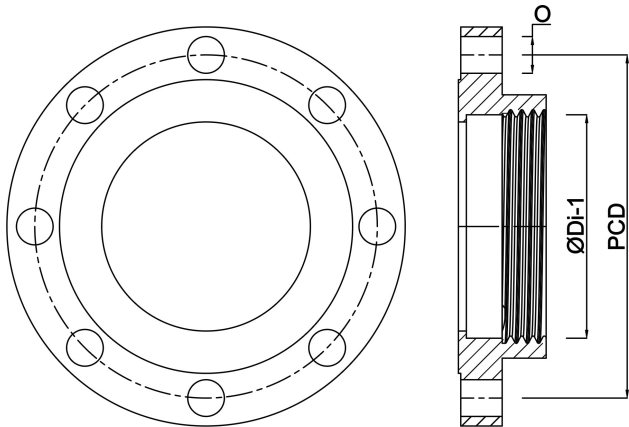

Genereret den: 23-05-2026

Bevo Nordic A/S
Pakhusgården 54
5000 Odense C
Danmark
+45 66 19 25 45
info@bevo.dk
<http://www.bevo.com>