

VDL Flangeovergang PVC-U 140 mm limmuffe 10bar DN125 grå PN10 type A (7018253)



V-L Van de Lande

TEKNISKE SPECIFIKATIONER

Farve grå

Materiale PVC-U

DIN Standard DIN 2501

Flange PN10

Tryk 10 bar

Type A

Størrelse 140 mm

Tilslutning limmuffe

Pakning 6 stk.

DN 125

Ydre Ø 76 mm

Tykkelse 26 mm

Bolthul 23 mm

Huller 8

DIMENSIONER

O 23 mm

PCD 215 mm

ØDi-1 140 mm

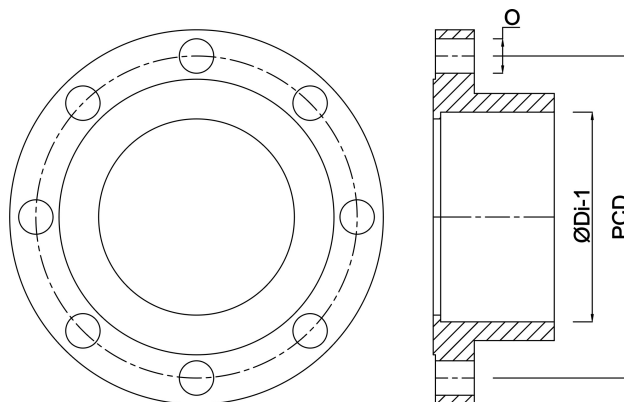

Genereret den: 24-05-2026

Bevo Nordic A/S
Pakhusgården 54
5000 Odense C
Danmark
+45 66 19 25 45
info@bevo.dk
<http://www.bevo.com>