

Profec Planflange stål DN150 x 159,0 mm DIN flange x stuksvejs 10bar PN10 (1180243)



TEKNISKE SPECIFIKATIONER

Materiale	stål
Tilslutning	DIN flange x stuksvejs
DIN Standard	DIN 2576
Flange	PN10
Tryk	10 bar
Størrelse	DN150 x 159,0 mm
Indre Ø	161,1 mm
Ydre Ø	285 mm
Vægt	6.97 kg
Tykkelse	22 mm
PCD	240 mm
Bolthul	22 mm
Huller	8

DIMENSIONER

O	22 mm
PCD	240 mm

ØDi-1

161.1 mm

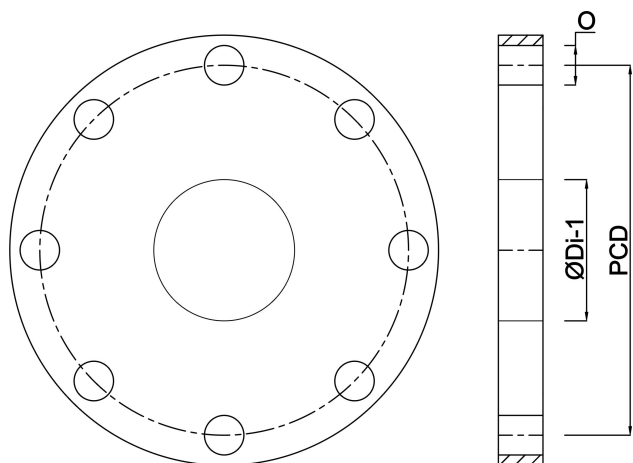

Genereret den: 24-05-2026

Bevo Nordic A/S
Pakhusgården 54
5000 Odense C
Danmark
+45 66 19 25 45
info@bevo.dk
<http://www.bevo.com>