

Profec Flange PVC-U DN50 x 2"
DIN flange x indvendig gevind
16bar DN50 grå PN10/16
(0111165)



TEKNISKE SPECIFIKATIONER

Farve	grå
Materiale	PVC-U
Tilslutning	DIN flange x indvendig gevind
Flange	PN10/16
Tryk	16 bar
Størrelse	DN50 x 2"
DN	50
Ydre Ø	165 mm
Vægt	0.42 kg
Tykkelse	18 mm
Bolthul	18 mm
Huller	4

DIMENSIONER

O	18 mm
PCD	125 mm
ØDi-1	2"

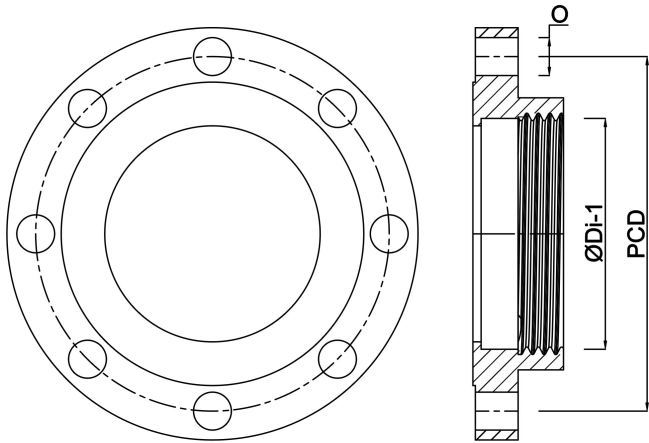

Genereret den: 13-03-2026

Bevo Nordic A/S
Pakhusgården 54
5000 Odense C
Danmark
+45 66 19 25 45
info@bevo.dk
<http://www.bevo.com>