

Flangering PP/stål PP 90 mm
SDR11 16bar DN80 sort
PN10/16 (0101935)



TEKNISKE SPECIFIKATIONER

Farve sort

Materiale PP/stål

Overfladebehandling PP

Klasse SDR11

Tryk 16 bar

Størrelse 90 mm

DN 80

Flange PN10/16

Ydre Ø 202 mm

Vægt 1.18 kg

Tykkelse 20 mm

Bolthul 18 mm

Huller 4

DIMENSIONER

O 18 mm

PCD 160 mm

ØDi-1

108 mm

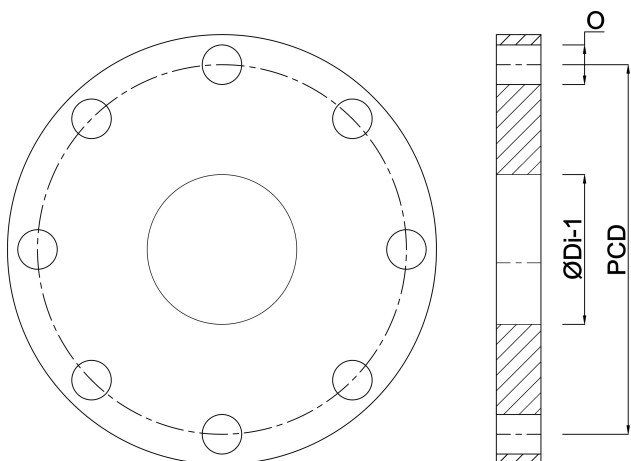

Genereret den: 22-05-2026

Bevo Nordic A/S
Pakhusgården 54
5000 Odense C
Danmark
+45 66 19 25 45
info@bevo.dk
<http://www.bevo.com>