

Profec Flangering PP 75 mm 16bar DN65 sort PN10/16 (0101388)



TEKNISKE SPECIFIKATIONER

Farve sort

Materiale PP

Størrelse 75 mm

Pakning 16 stk.

DN 65

Indre Ø 92 mm

Flange PN10/16

Ydre Ø 185 mm

Tykkelse 20 mm

Tryk 16 bar

Bolthul 18 mm

Huller 4

DIMENSIONER

O 18 mm

PCD 145 mm

ØDi-1 92 mm

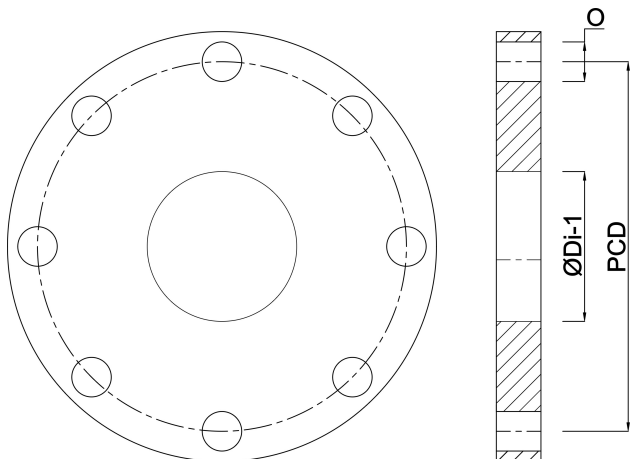

Genereret den: 22-05-2026

Bevo Nordic A/S
Pakhusgården 54
5000 Odense C
Danmark
+45 66 19 25 45
info@bevo.dk
<http://www.bevo.com>