

**Profec Flangeovergang PVC-U  
DN100 x 110 mm DIN flange x  
limmuffe 16bar DN100 grå  
PN10/16 (0111048)**



# TEKNISKE SPECIFIKATIONER

Farve	grå
Materiale	PVC-U
Tilslutning	DIN flange x limmuffe
Størrelse	DN100 x 110 mm
Bolt	
DN	100
Flange	PN10/16
Ydre Ø	220 mm
Vægt	1.07 kg
Boltlængde	100 mm
Tykkelse	22 mm
Tryk	16 bar
Bolthul	18 mm
Huller	8

## DIMENSIONER

O	18 mm
---	-------

PCD 180 mm

ØDi-1 110 mm

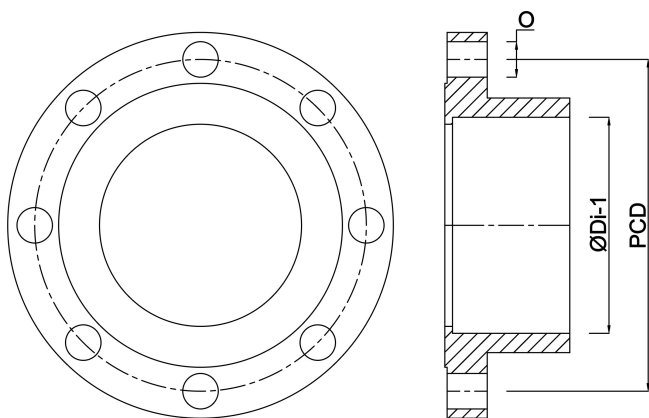

**Genereret den: 13-03-2026**

Bevo Nordic A/S  
Pakhusgården 54  
5000 Odense C  
Danmark  
+45 66 19 25 45  
[info@bevo.dk](mailto:info@bevo.dk)  
<http://www.bevo.com>