

VDL Unionskobling PVC-U 63 mm x 2" limmuffe x indvendig gevind 16bar grå type forstærket (7018220)



V-L Van de Lande

TEKNISKE SPECIFIKATIONER

Farve	grå
Type	forstærket
Materiale	PVC-U
Pakningsmateriale	EPDM
Tilslutning	limmuffe x indvendig gevind
Størrelse	63 mm x 2"
Tryk	16 bar

DIMENSIONER

F-2	27 mm
L	96 mm
ØDi-1	63 mm
ØDi-2	2"

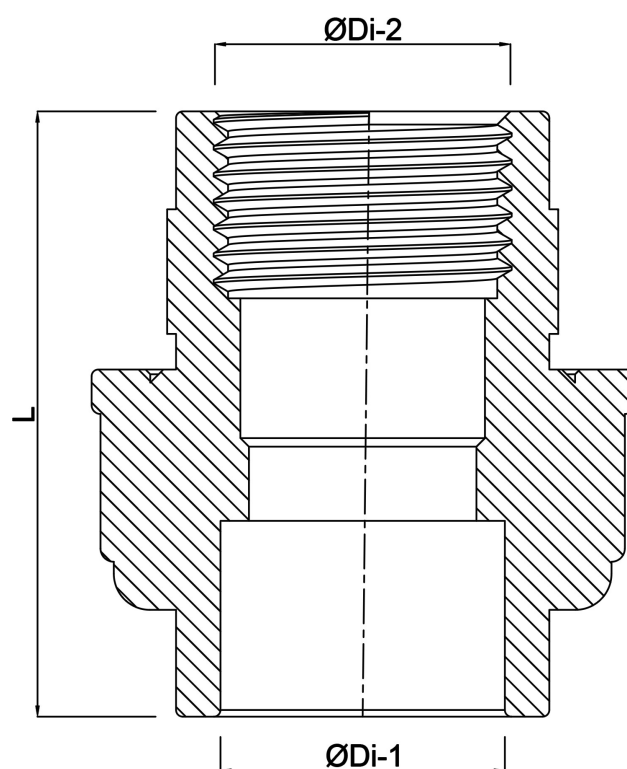

Genereret den: 25-05-2026

Bevo Nordic A/S
Pakhusgården 54
5000 Odense C
Danmark
+45 66 19 25 45
info@bevo.dk
<http://www.bevo.com>