

**Flange PP DN65 x 2 1/2" DIN
flange x indvendig gevind 6bar
DN65 sort PN10/16 type
forstærket (0707206)**



TEKNISKE SPECIFIKATIONER

Farve	sort
Type	forstærket
Materiale	PP
Pakningsmateriale	gummi
Tilslutning	DIN flange x indvendig gevind
Flange	PN10/16
Tykkelse	18 mm
Bolthul	18 mm
Størrelse	DN65 x 2 1/2"
Pakning	65 stk.
DN	65
Ydre Ø	195 mm
Tryk	6 bar
Huller	4

DIMENSIONER

O	18 mm
---	-------

PCD

145 mm

ØDi-1

2 1/2 "

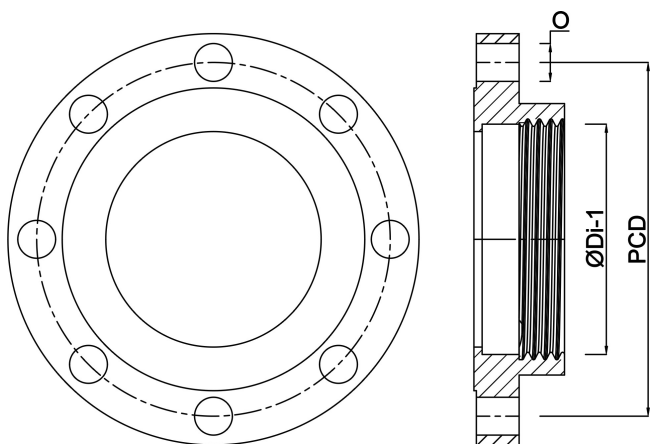

Genereret den: 13-03-2026

Bevo Nordic A/S
Pakhusgården 54
5000 Odense C
Danmark
+45 66 19 25 45
info@bevo.dk
<http://www.bevo.com>