

Profec Flange PVC-U DN25 x 1"
DIN flange x indvendig gevind
16bar DN25 grå PN10/16
(0111162)

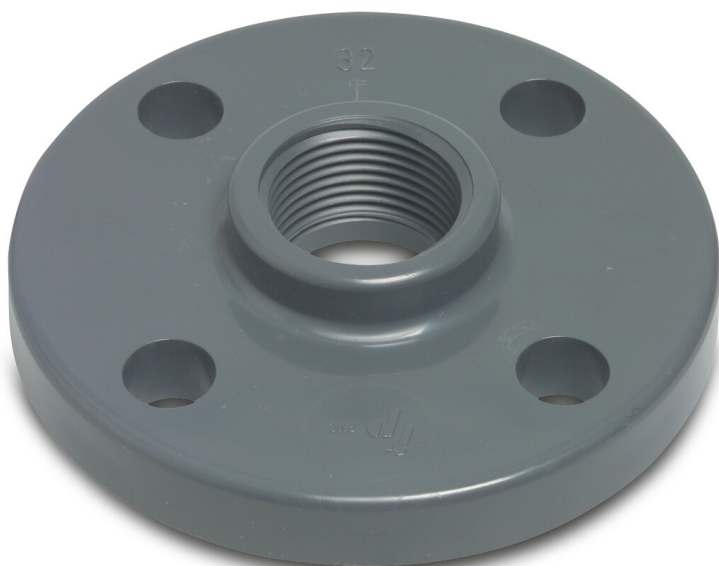

TEKNISKE SPECIFIKATIONER

Farve	grå
Materiale	PVC-U
Tilslutning	DIN flange x indvendig gevind
Flange	PN10/16
Tryk	16 bar
Størrelse	DN25 x 1"
DN	25
Ydre Ø	115 mm
Vægt	0.142 kg
Tykkelse	14 mm
Bolthul	14 mm
Huller	4

DIMENSIONER

O	14 mm
PCD	85 mm
ØDi-1	1 "

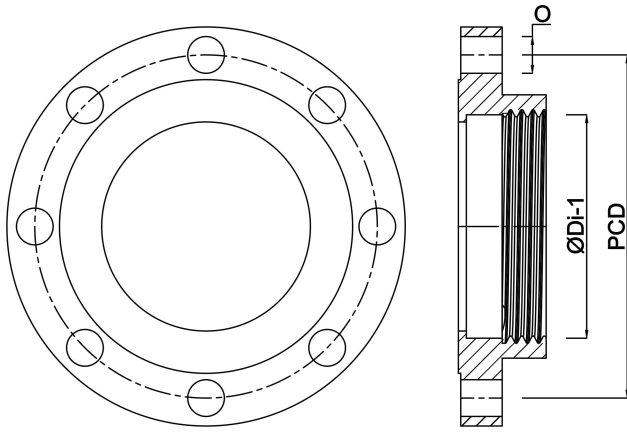

Genereret den: 23-05-2026

Bevo Nordic A/S
Pakhusgården 54
5000 Odense C
Danmark
+45 66 19 25 45
info@bevo.dk
<http://www.bevo.com>