

Profec Planflange stål DN100 x 114,3 mm DIN flange x stuksvejs 10bar PN10 (1180238)



TEKNISKE SPECIFIKATIONER

Materiale	stål
Tilslutning	DIN flange x stuksvejs
DIN Standard	DIN 2576
Flange	PN10
Tryk	10 bar
Størrelse	DN100 x 114,3 mm
Indre Ø	115,9 mm
Ydre Ø	220 mm
Vægt	3.99 kg
Tykkelse	20 mm
PCD	180 mm
Bolthul	18 mm
Huller	8

DIMENSIONER

O	18 mm
PCD	180 mm

ØDi-1

115.9 mm

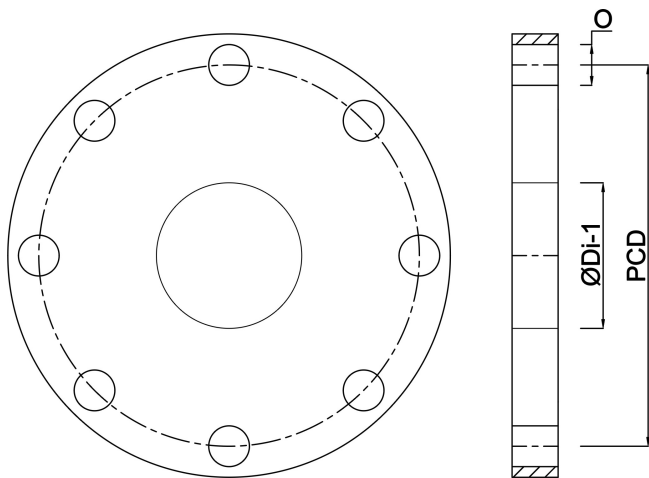

Genereret den: 14-03-2026

Bevo Nordic A/S
Pakhusgården 54
5000 Odense C
Danmark
+45 66 19 25 45
info@bevo.dk
<http://www.bevo.com>