

VDL Flangeovergang PVC-U 280 mm limmuffe 10bar DN250 grå PN10 type A (0111056)



V-L Van de Lande

TEKNISKE SPECIFIKATIONER

Farve grå

Materiale PVC-U

DIN Standard DIN 2501

Flange PN10

Tryk 10 bar

Type A

Størrelse 280 mm

Tilslutning limmuffe

Pakning 2 stk.

DN 250

Ydre Ø 146 mm

Tykkelse 36 mm

Bolthul 22 mm

Huller 12

DIMENSIONER

O 22 mm

PCD 350 mm

ØDi-1 280 mm

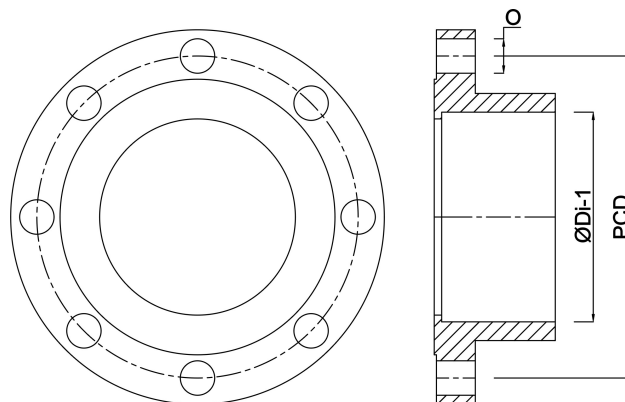

Genereret den: 24-05-2026

Bevo Nordic A/S
Pakhusgården 54
5000 Odense C
Danmark
+45 66 19 25 45
info@bevo.dk
<http://www.bevo.com>