

Profec Flangering PP 90 mm
16bar DN80 sort PN10/16
(0101389)



TEKNISKE SPECIFIKATIONER

Farve sort

Materiale PP

Størrelse 90 mm

Pakning 16 stk.

DN 80

Indre Ø 110 mm

Flange PN10/16

Ydre Ø 200 mm

Tykkelse 22 mm

Tryk 16 bar

Bolthul 18 mm

Huller 8

DIMENSIONER

O 18 mm

PCD 160 mm

ØDi-1 110 mm

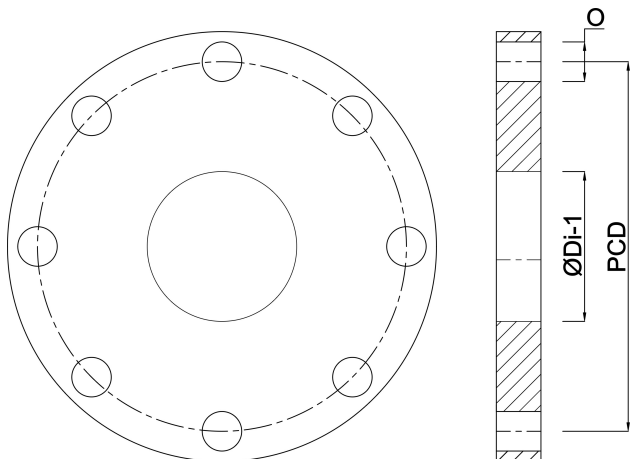

Genereret den: 22-05-2026

Bevo Nordic A/S
Pakhusgården 54
5000 Odense C
Danmark
+45 66 19 25 45
info@bevo.dk
<http://www.bevo.com>