

**Profec Flangeovergang PVC-U  
DN25 x 32 mm DIN flange x  
limmuffe 10bar DN25 grå PN10  
(0111082)**



# TEKNISKE SPECIFIKATIONER

Farve	grå
Materiale	PVC-U
Tilslutning	DIN flange x limmuffe
Størrelse	DN25 x 32 mm
Bolt	
DN	25
Flange	PN10
Ydre Ø	115 mm
Vægt	0.137 kg
Boltlængde	60 mm
Tykkelse	14 mm
Tryk	10 bar
Bolthul	14 mm
Huller	4

## DIMENSIONER

O	14 mm
---	-------

PCD

85 mm

ØDi-1

32 mm

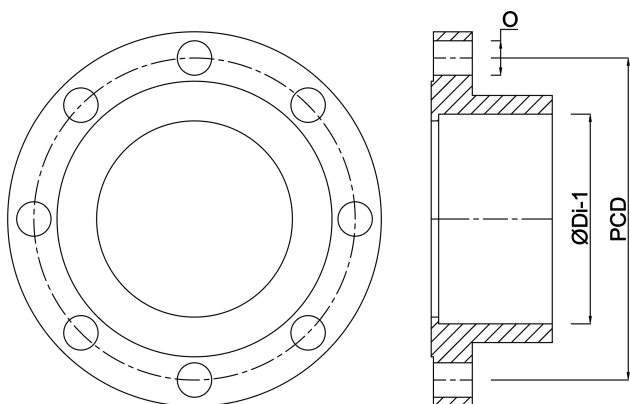

**Genereret den: 23-05-2026**

Bevo Nordic A/S  
Pakhusgården 54  
5000 Odense C  
Danmark  
+45 66 19 25 45  
[info@bevo.dk](mailto:info@bevo.dk)  
<http://www.bevo.com>