

Profec Flangering PP 125 mm
16bar DN110 sort PN10/16
(0101391)



TEKNISKE SPECIFIKATIONER

Farve sort

Materiale PP

Størrelse 125 mm

Pakning 6 stk.

DN 110

Indre Ø 149 mm

Flange PN10/16

Ydre Ø 230 mm

Tykkelse 26 mm

Tryk 16 bar

Bolthul 18 mm

Huller 8

DIMENSIONER

O 18 mm

PCD 190 mm

ØDi-1 149 mm

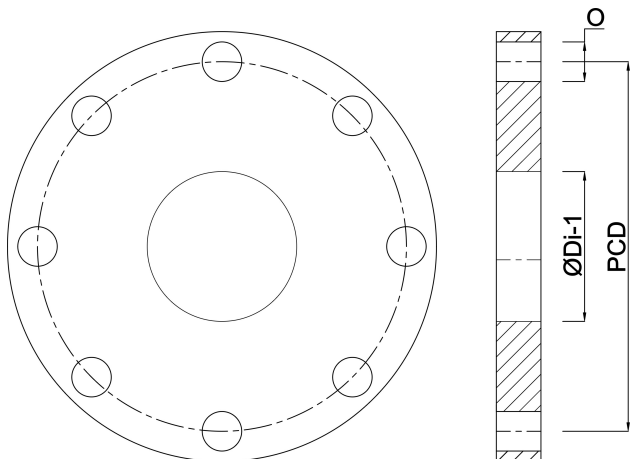

Genereret den: 22-05-2026

Bevo Nordic A/S
Pakhusgården 54
5000 Odense C
Danmark
+45 66 19 25 45
info@bevo.dk
<http://www.bevo.com>