

Flangering PP 160 mm 16bar DN150 sort PN10/16 (0101911)



TEKNISKE SPECIFIKATIONER

Farve sort

Materiale PP

Tryk 16 bar

Huller 8

Egnet til 0110909

Størrelse 160 mm

DN 150

Flange PN10/16

Ydre Ø 285 mm

Vægt 2.21 kg

Tykkelse 23 mm

Bolthul 22 mm

DIMENSIONER

O 22 mm

PCD 240 mm

ØDi-1 190 mm

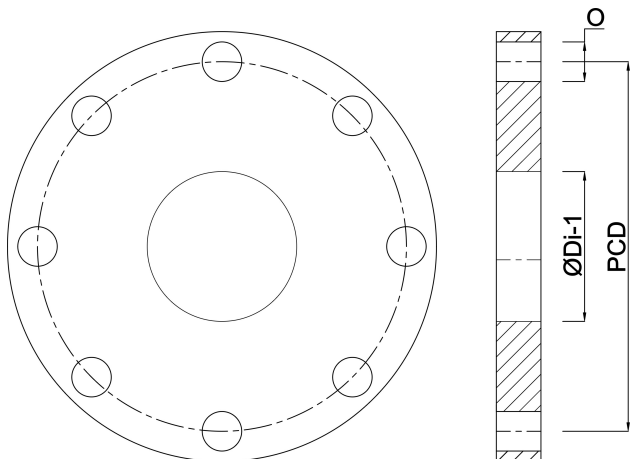

Genereret den: 22-05-2026

Bevo Nordic A/S
Pakhusgården 54
5000 Odense C
Danmark
+45 66 19 25 45
info@bevo.dk
<http://www.bevo.com>