

Profec Kugelhahn PVC-U 63 mm Klebemuffe 16bar DN50 Grau Typ Safe 600 (0112106)



TECHNISCHE DATEN

Farbe Grau

Typ Safe 600

Werkstoff PVC-U

Bedienung Hebel

Griff-Farbe Rot

Material Hebel/Griff PVC-U

Gehäusekonstruktion 3-teilig

Material Kugel PVC-U

Material Spindel PVC-U

Material Gehäuse PVC-U

Material Dichtung hytrel/EPDM

Anschluss Klebemuffe

Max. Temperatur 60 °C

Minimale Mediumtemperatur 0 °C
(kontinuierlich)

Arbeitsdruck 16 bar

Maß 63 mm

DN

50

ABMESSUNGEN

Ct-1 107 mm

Lb 190 mm

R 74 mm

ØDf 50 mm

ØDi-1 63 mm

ØDi-2 63 mm

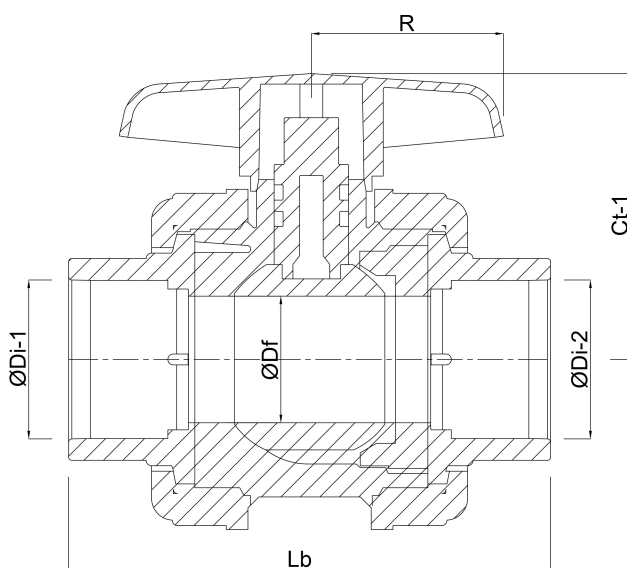

PRODUKTINFORMATIONEN

Mit gesicherter Kugel.

Generiert am: 23.05.2026

bevo Vertriebs GmbH
Industriestraße 18
32602 VLOTHO-EXTER
Deutschland
+49 (0) 5228 959 0
info@bevo.com
<http://www.bevo.com>