

Profec Kugelhahn PVC-U 75 mm Klebemuffe 16bar DN65 Grau Typ Safe 600 (0112107)



DN

65

ABMESSUNGEN

Ct-1 122 mm

Lb 214 mm

R 100 mm

ØDf 65 mm

ØDi-1 75 mm

ØDi-2 75 mm

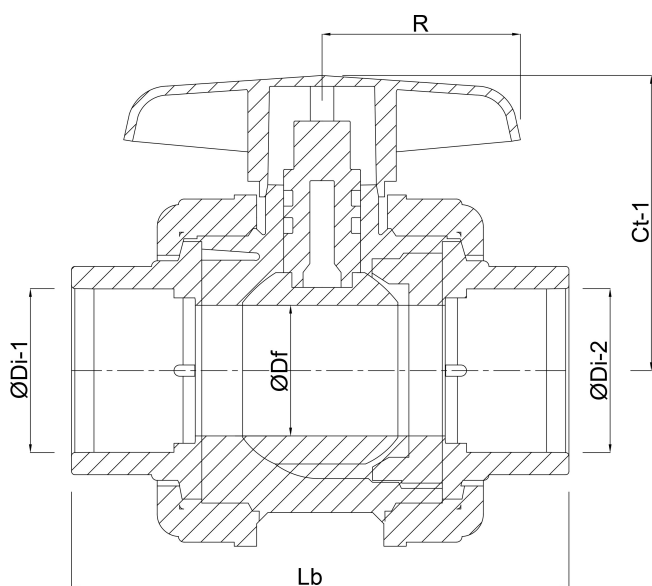

PRODUKTINFORMATIONEN

Mit gesicherter Kugel.

Generiert am: 17.04.2026

bevo Vertriebs GmbH
Industriestraße 18
32602 VLOTHO-EXTER
Deutschland
+49 (0) 5228 959 0
info@bevo.com
<http://www.bevo.com>