

Profec Kugelhahn PVC-U 16 mm Klebemuffe 16bar DN15 Grau Typ Safe 600 (0112100)



DN

15

ABMESSUNGEN

Ct-1

46 mm

Lb

84 mm

R

35 mm

ØDf

10 mm

ØDi-1

16 mm

ØDi-2

16 mm

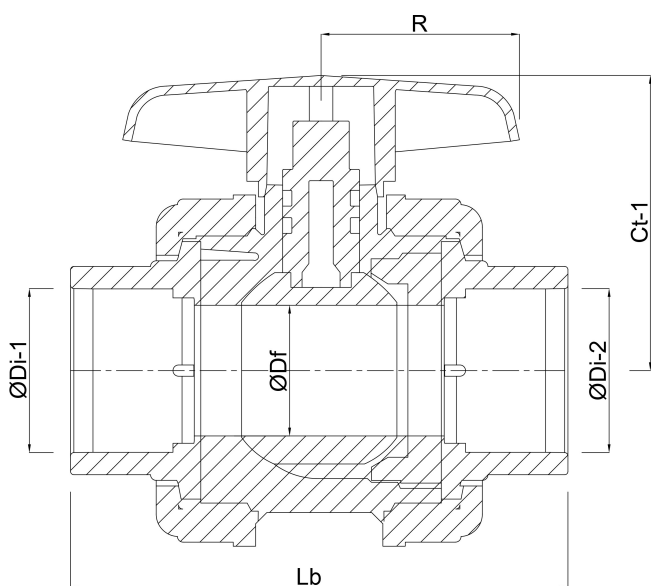

PRODUKTINFORMATIONEN

Mit gesicherter Kugel.

Generiert am: 17.04.2026

bevo Vertriebs GmbH
Industriestraße 18
32602 VLOTHO-EXTER
Deutschland
+49 (0) 5228 959 0
info@bevo.com
<http://www.bevo.com>