

Profec Kugelhahn PVC-U 90 mm Klebemuffe 16bar DN80 Grau Typ Safe 600 (0112108)



DN

80

ABMESSUNGEN

Ct-1 148 mm

Lb 249 mm

R 123 mm

ØDf 80 mm

ØDi-1 90 mm

ØDi-2 90 mm

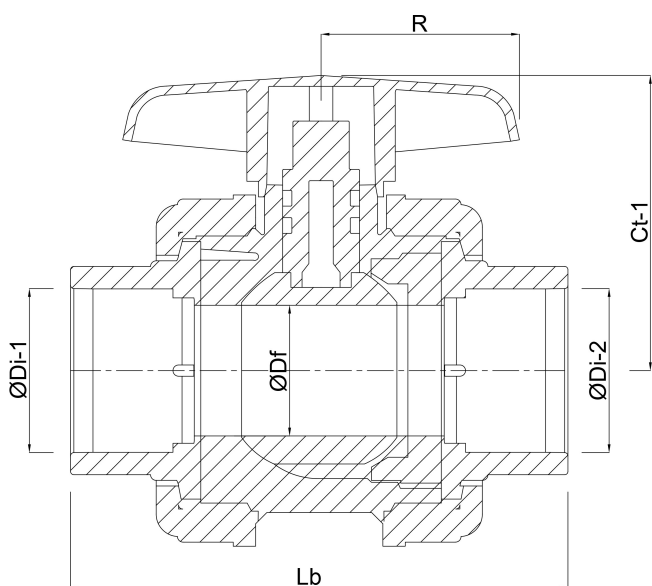

PRODUKTINFORMATIONEN

Mit gesicherter Kugel.

Generiert am: 17.04.2026

bevo Vertriebs GmbH
Industriestraße 18
32602 VLOTHO-EXTER
Deutschland
+49 (0) 5228 959 0
info@bevo.com
<http://www.bevo.com>