

**Profec Kugelhahn PVC-U 40
mm Klebemuffe 16bar DN32
Grau Typ Safe 600 (0112104)**



DN

32

ABMESSUNGEN

Ct-1 93 mm

Lb 149 mm

R 65 mm

ØDf 32 mm

ØDi-1 40 mm

ØDi-2 40 mm

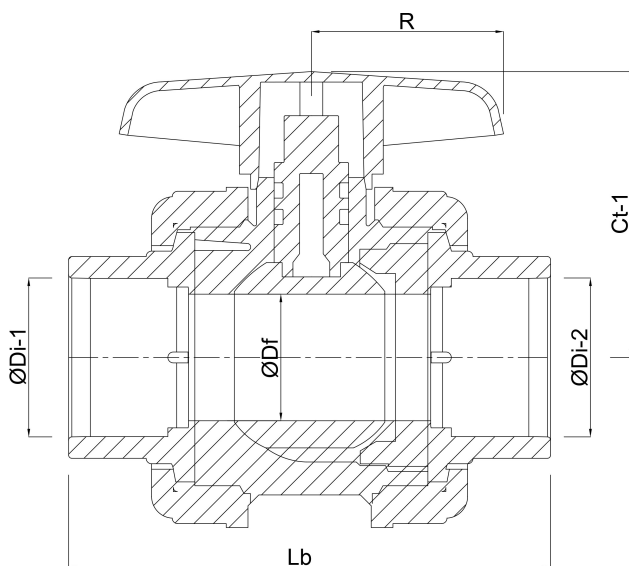

PRODUKTINFORMATIONEN

Mit gesicherter Kugel.

Generiert am: 23.05.2026

bevo Vertriebs GmbH
Industriestraße 18
32602 VLOTHO-EXTER
Deutschland
+49 (0) 5228 959 0
info@bevo.com
<http://www.bevo.com>