

**DAB Dränkbar pump rostfritt
stål 304 1 1/2" invändig gänga
7,5A 230VAC rostfritt stål type
Drenag 1200 MA med flytande
kontakt (7038202)**



TEKNISKA SPECIFIKATIONER

Färg	rostfritt stål
Material	rostfritt stål 304
Pump body	rostfritt stål 304
Anslutning	invändig gänga
Volt	230VAC
Max temperatur	35 °C
Minste mellantemperatur (kontinuerlig)	0 °C
Max omgivningstemperatur	40 °C
Typ	Drenag 1200 MA
Uteffekt	1,6 Hk
Material impeller 1	rostfritt stål 304
MWC	17 m
Storlek	1 1/2"
Flyter	inkluderad
Effekt	1.2 kW
Ampere	7,5 A

Max flow rate

24 m³/h

DIMENSIONER

A 215 mm

C 175 mm

D 71 mm

H 413 mm

H-1 385 mm

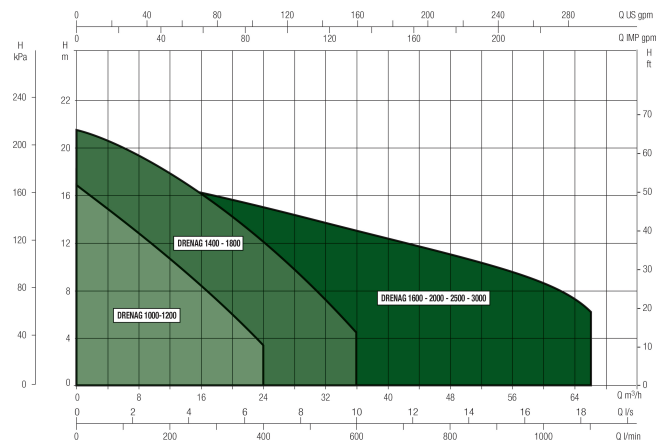
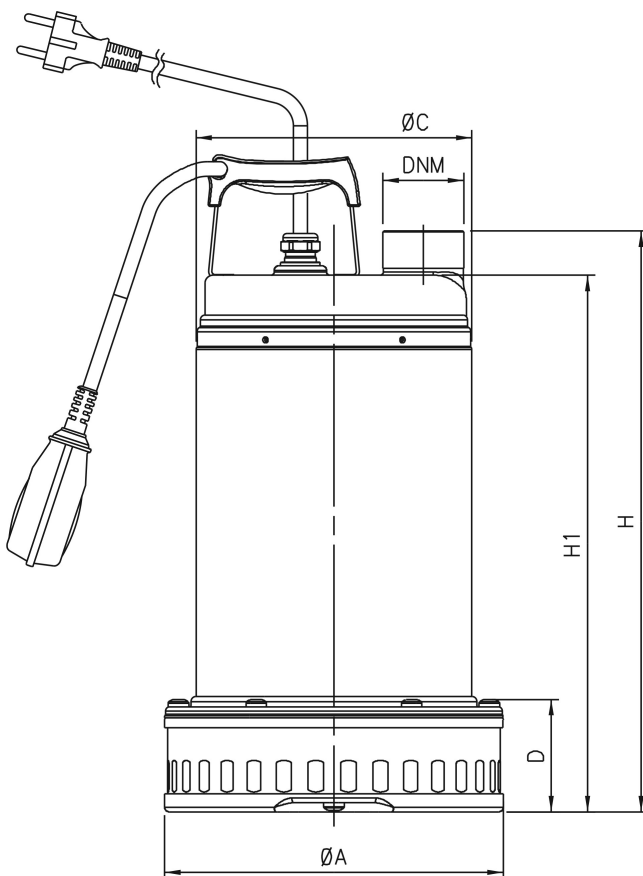

Genererad den: 08/05/2026

Bevo Nordic A/S
Pakhusgården 54
5000 Odense C
Danmark
+45 66 19 25 45
info@bevo.dk
<http://www.bevo.com>