

Profec Svetsfläns stål DN40 x 48,3 mm DIN fläns x svetsning svart PN16 (1180478)



TEKNISKA SPECIFIKATIONER

Färg svart

Material stål

Anslutning DIN fläns x svetsning

DIN Standard DIN 2633

Fläns PN16

Storlek DN40 x 48,3 mm

Yttre Ø 150 mm

Vikt 1.83 kg

Höjd 42 mm

Tjocklek 16 mm

PCD 110 mm

Bulthål 18 mm

Hål 4

DIMENSIONER

O 18 mm

PCD 110 mm

ØDi-1

43.1 mm

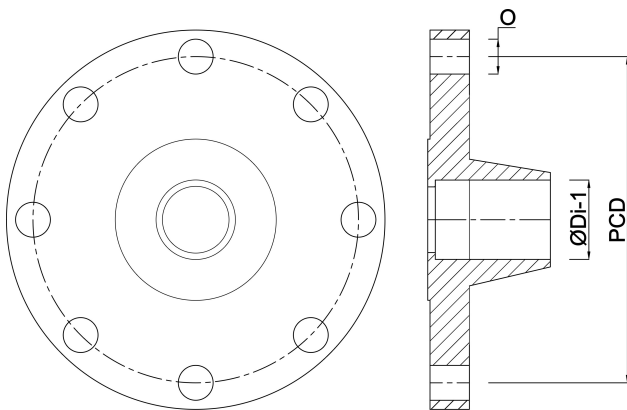

Genererad den: 24/05/2026

Bevo Nordic A/S
Pakhusgården 54
5000 Odense C
Danmark
+45 66 19 25 45
info@bevo.dk
<http://www.bevo.com>