

Profec Kulventil brons 1" invändig gänga 16bar type 160 (0400278)



TEKNISKA SPECIFIKATIONER

Typ	160
Material	brons
Funktion	handtag
Handtagsfärg	blå
Handtagsmaterial	stål
Kulmaterial	hård krompläterat mässing
Materialhus	brons
Packningsmaterial	PFTE
Anslutning	invändig gänga
Max temperatur	150 °C
Tryck	16 bar
Storlek	1"

DIMENSIONER

Ct-1	63 mm
F-1	16.5 mm
F-2	16.5 mm

Lb 64,3 mm

R 123 mm

ØDf 24.5 mm

ØDi-1 1 "

ØDi-2 1 "

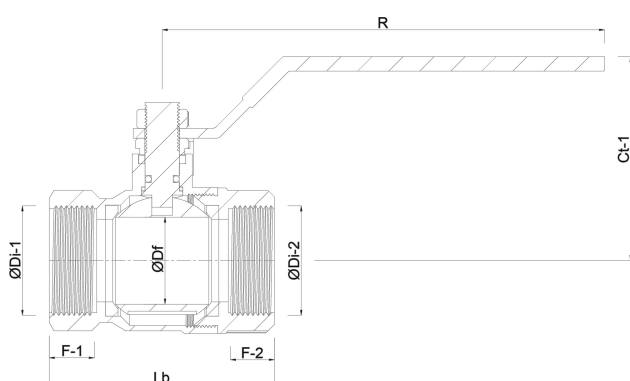

Genererad den: 23/05/2026

Bevo Nordic A/S
Pakhusgården 54
5000 Odense C
Danmark
+45 66 19 25 45
info@bevo.dk
<http://www.bevo.com>