

**Profec Nr. 41 Böj 45° gjutjärn
galvaniserad 2 1/2" invändig
gänga 25bar DVGW (1004109)**



TEKNISKA SPECIFIKATIONER

Material	gjutjärn
Ytbehandling	galvaniserad
Godkännande	DVGW
Anslutning	invändig gänga
Fitting nr.	Nr. 41
Temperatur intervall	-20°C - 120°C
Tryck	25 bar
Storlek	2 1/2"

DIMENSIONER

Cb-1	99 mm
Cb-2	86 mm
ØDi-1	2 1/2 "
ØDi-2	2 1/2 "
β	45 °

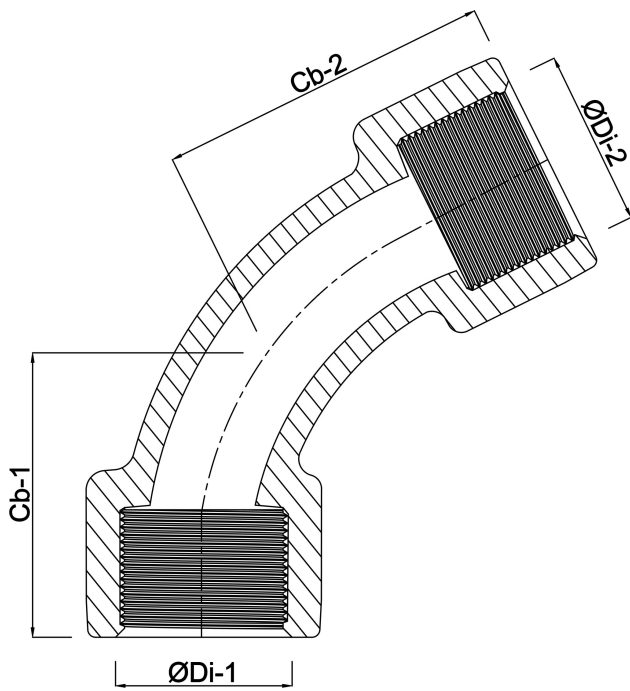

Genererad den: 28/05/2026

Bevo Nordic A/S
Pakhusgården 54
5000 Odense C
Danmark
+45 66 19 25 45
info@bevo.dk
<http://www.bevo.com>