

VDL Unionskoppling PVC-U 3/4" x 25 mm invändig gänga x limsockel 10bar grå type A (7002855)



V-L Van de Lande

TEKNISKA SPECIFIKATIONER

Färg	grå
Typ	A
Material	PVC-U
Packningsmaterial	EPDM
Anslutning	invändig gänga x limsockel
Storlek	3/4" x 25 mm
Tryck	10 bar

DIMENSIONER

F-2	17 mm
L	61 mm
ØDi-1	25 mm
ØDi-2	3/4 "

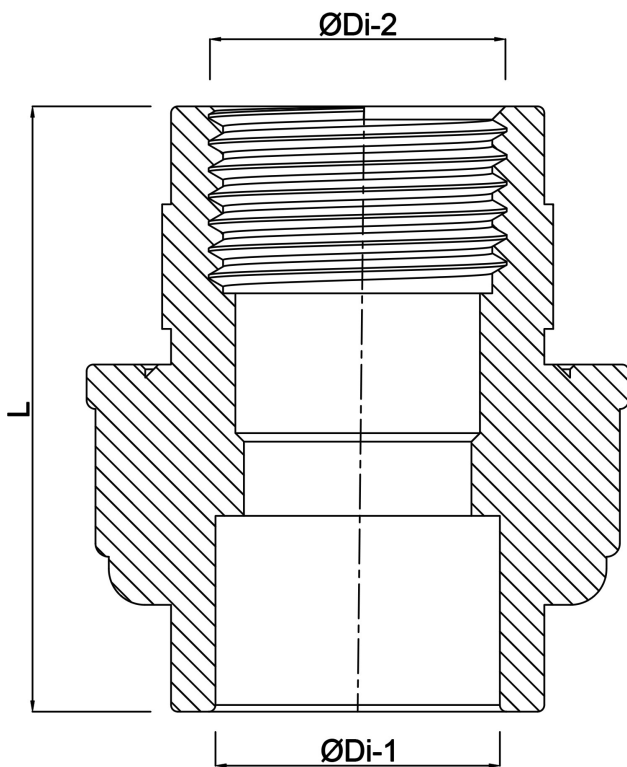

Genererad den: 24/05/2026

Bevo Nordic A/S
Pakhusgården 54
5000 Odense C
Danmark
+45 66 19 25 45
info@bevo.dk
<http://www.bevo.com>