

**Svetsböj 90° stål 60,3 mm x  
60,3 mm x 2,9 mm svetsning  
(1180050)**



# TEKNISKA SPECIFIKATIONER

Material stål

Anslutning svetsning

DIN Standard DIN 2605

Norm 3S

Storlek 60,3 mm

Väggjocklek 2,9 mm

## DIMENSIONER

Cb-1 76 mm

Cb-2 76 mm

ØDo-1 60.3 mm

ØDo-2 60.3 mm

β 90 °

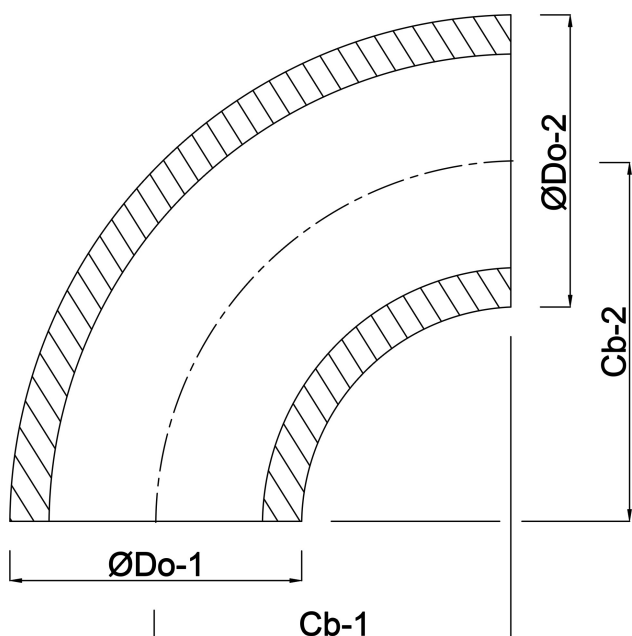

**Genererad den: 24/05/2026**

Bevo Nordic A/S  
Pakhusgården 54  
5000 Odense C  
Danmark  
+45 66 19 25 45  
[info@bevo.dk](mailto:info@bevo.dk)  
<http://www.bevo.com>