

Profec Fläns stål DN50 x 60,3 mm DIN fläns x svetsning 10bar PN10 (1180235)



TEKNISKA SPECIFIKATIONER

Material	stål
Anslutning	DIN fläns x svetsning
DIN Standard	DIN 2576
Fläns	PN10
Tryck	10 bar
Storlek	DN50 x 60,3 mm
Inner Ø	61,1 mm
Yttre Ø	165 mm
Vikt	2.46 kg
Tjocklek	18 mm
PCD	125 mm
Bulthål	18 mm
Hål	4

DIMENSIONER

O	18 mm
PCD	125 mm

ØDi-1

61.1 mm

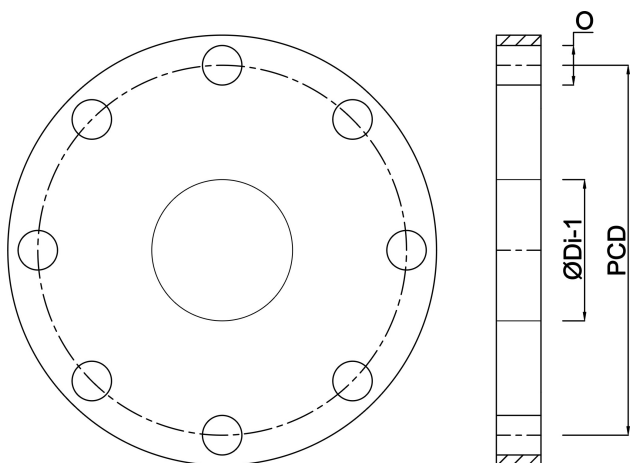

Genererad den: 24/05/2026

Bevo Nordic A/S
Pakhusgården 54
5000 Odense C
Danmark
+45 66 19 25 45
info@bevo.dk
<http://www.bevo.com>